

# Technical data sheet

## Rung WSK 40

Item number: 6008089



Angle profile rungs for use in heavy-duty vertical ladders and in IS 8 supports.  
The maximum rung load is 250 kg.

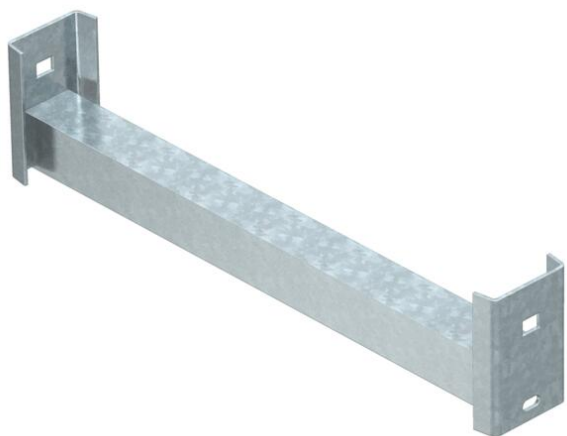

**St** Steel

**FT** Hot-dip galvanised

### Master data

Item number	6008089
Type	WSK 40 80 FT
Description 1	Angle rung
Description 2	for IS 8 support
Manufacturer	OBO
Dimension	B754mm
Material	Steel
Surface	Hot-dip galvanised
Surface standard	DIN EN ISO 1461
Smallest sales unit	1
Unit of quantity	Piece
Weight	222 kg
Weight unit	kg/100 pc.

# Technical data sheet

Rung WSK 40

Item number: 6008089



## Dimensions

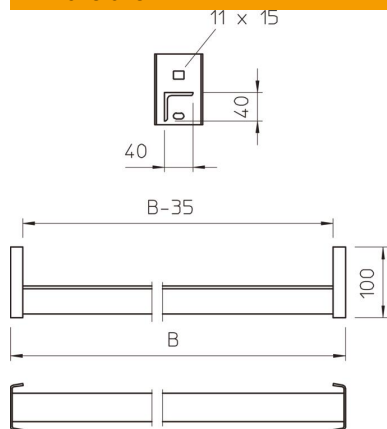

lampDimension WxH	40 x 40 mm
Length	754 mm
Width	754 mm
Height	100 mm

## Technical data

Material thickness	4 mm
--------------------	------