

# Technical data sheet

## Cover for add-on tee FS

Item number: 6231916



Cover for wide span add-on tee with pre-mounted turn buckles.

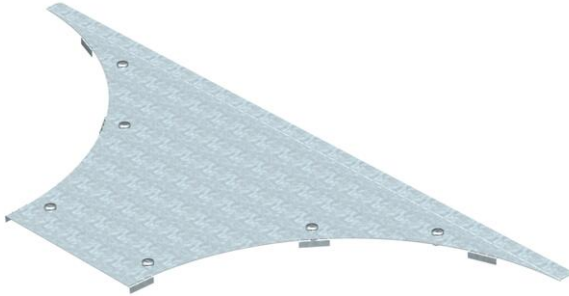

- St** Steel
- FS** Strip galvanized

### Master data

Item number	6231916
Description 1	Cover, add-on tee
Description 2	wide span system 110 and 160
Manufacturer	OBO
Dimension	B600mm
Material	Steel
Surface	Strip galvanized
Surface standard	DIN EN 10346
Smallest sales unit	1
Unit of quantity	Piece
Weight	552.1 kg
Weight unit	kg/100 pc.

### Dimensions

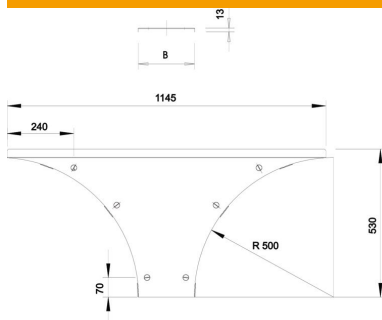

Width	600 mm
Height	110 mm
Plate thickness	1.5 mm
Dimension B	600 mm
Dimension H	15 mm
Dimension R	500 mm

# Technical data sheet

Cover for add-on tee FS

Item number: 6231916



## Technical data

Number of turn buckles	6 St.
Fastening type	Sash lock
Suitable for cable ladder	yes
Suitable for cable tray	yes
Material thickness	1.5 mm
Rustproof steel, pickled	no
Wide-span version	yes