

Technical data sheet

Cable ladder with trapezoidal rungs, light duty ALU

Item number: 7099724



Shipbuilding cable ladder with perforated side rail of side height 25 mm with welded, perforated trapezoidal rungs which open in a downwards direction. The shipbuilding cable ladder is also available in unpainted steel on request.

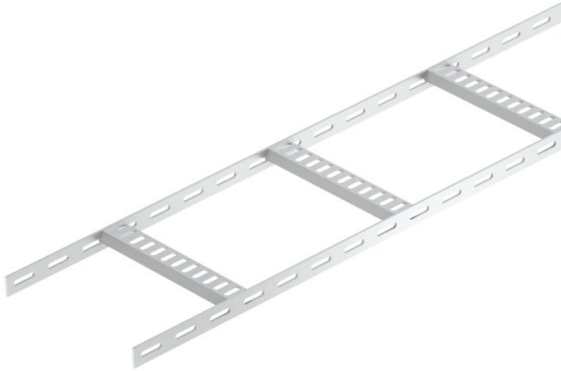

Alu Aluminium

GB Pickled

Master data

Item number	7099724
Type	SL 42 100 ALU
Description 1	Cable ladder, shipbuilding
Description 2	with trapezoidal rung
Manufacturer	OBO
Dimension	25x106x2000
Material	Aluminium
Surface	Pickled
Surface standard	
Smallest sales unit	2
Unit of quantity	Metre
Weight	43 kg
Weight unit	kg/100 m

Technical data sheet

Cable ladder with trapezoidal rungs, light duty ALU



Item number: 7099724

Dimensions

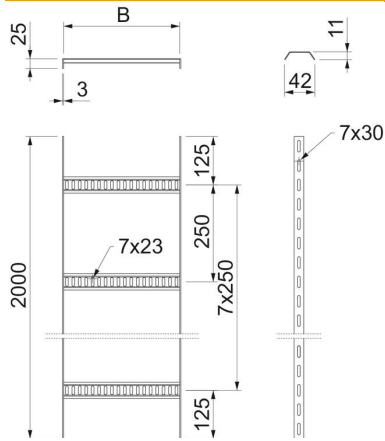

Length	2,000 mm
Length	2,000 ft
Width	100 mm
Height	25 mm
Dimension B	106 mm

Technical data

Version of the rungs	Profile perforated
Side rail version	Flat profile
Fastening of rung	Welded
Maintain electrical functions	no
Rustproof steel, pickled	no
Side perforation	yes
Rung distance	250 mm
Wide-span version	no
Rail thickness	3 mm

Loads

Support spacing 1.0 m	0.75 kN/m
Support spacing 1.5 m	0.2 kN/m
Support spacing 2.0 m	0.1 kN/m

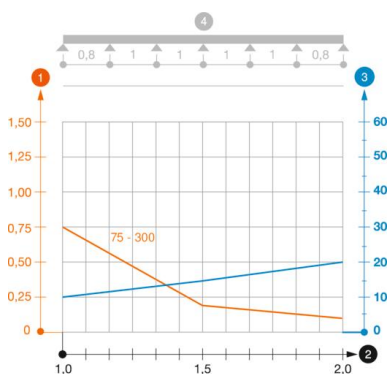

Load diagram, cable ladder, type SL42 ALU

- 1 Permitted cable tray/ladder load in kN/m without man load
- 2 Support width in m
- 3 Rail bend in mm at permitted kN/m
- Load curve with cable tray/ladder width in mm
- Strut bend curve according to support width
- 4 Load scheme during testing