

Technical data sheet

SLL 60 medium-duty vertical ladder, 6 m, FS

Item number: 6010628



Vertical ladder with a side height of 60 mm with riveted C profile rungs, open in upwards direction.
Fastening takes place directly on the wall or using the wall brackets, type WB 30/75. The slot dimension of the rung is 18 mm and the appropriate clamp clip is type 2056U.



- St** Steel
- FS** Strip galvanized

Master data

Item number	6010628
Type	SLL 660 CPS 4 FS
Description 1	Medium duty vertical ladder
Description 2	with CPS rung
Manufacturer	OBO
Dimension	60x600x6000
Material	Steel
Surface	Strip galvanized
Surface standard	DIN EN 10346
Smallest sales unit	6
Unit of quantity	Metre
Weight	379.433 kg
Weight unit	kg/100 m

Technical data sheet

SLL 60 medium-duty vertical ladder, 6 m, FS

Item number: 6010628



Dimensions

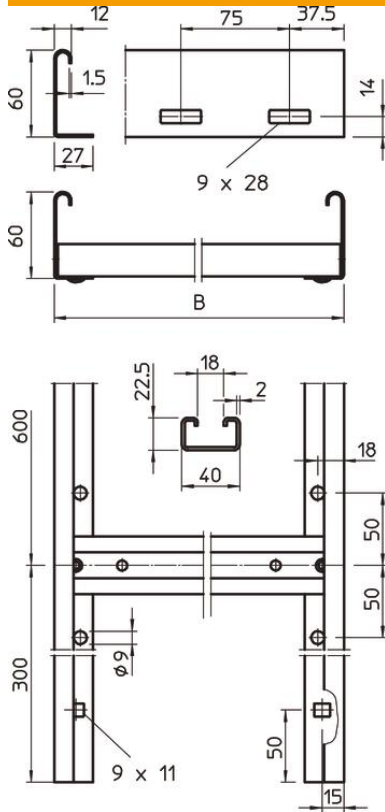

Length	6,000 mm
Width	600 mm
Height	60 mm
Dimension B	600 mm
Rung slot dimension	18.00

Technical data

Side wall version	Flat profile
Version of the rungs	Profile perforated
Maintain electrical functions	no
Usable cross-section	228 cm ²
Rustproof steel, pickled	no
Side perforation	yes
Rung distance	600 mm
Rail thickness	1.5 mm