

Technical data sheet

Cable tray SKS-Magic® 110, unperforated FT

Item number: 6059865

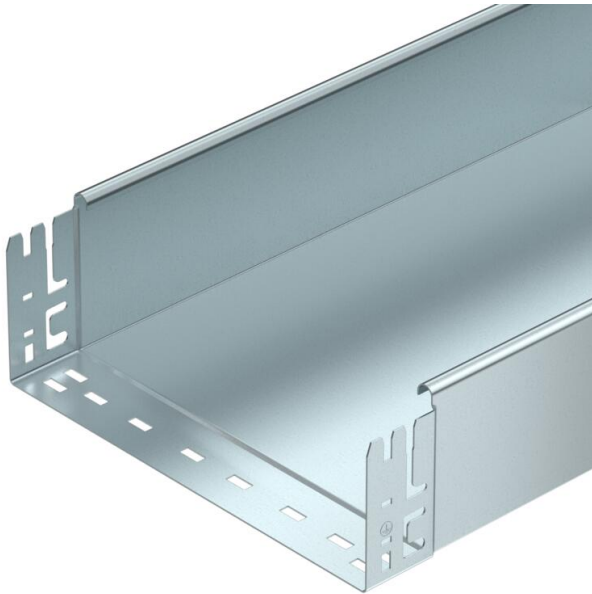

Unperforated cable tray with integrated quick fastening system. The usable length of the cable tray is 3,000 mm. Continuous equipotential bonding is guaranteed without additional components.



- St** Steel
- FT** Hot-dip galvanised

Master data

Item number	6059865
Type	SKSMU 160 FT
Description 1	Cable tray SKSMU
Description 2	unperforated, quick connector
Manufacturer	OBO
Dimension	110x600x3050
Material	Steel
Surface	Hot-dip galvanised
Surface standard	DIN EN ISO 1461
Smallest sales unit	3
Unit of quantity	Metre
Weight	1058.163 kg
Weight unit	kg/100 m

Technical data sheet

Cable tray SKS-Magic® 110, unperforated FT

Item number: 6059865



Dimensions

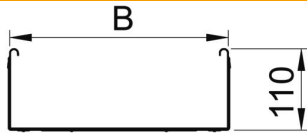

Length	3,050 mm
Width	600 mm
Height	110 mm
Plate thickness	1.5 mm
Dimension B	600 mm



Technical data

Connector version	Integrated connector
Mounting system fastening type	Floor Ceiling Wall
Walkable	no
Maintain electrical functions	no
With cover	no
Mounting perforation in base	no
NATO hole pattern	no
Usable cross-section	655 cm ²
Usable cross-section	65500 mm ²
Rustproof steel, pickled	no
Side perforation	no
Wide-span version	no
Load test type according to IEC 61537	Type II
Usable length	3000 mm
Type of connector, cable support system	Click fastening

Technical data sheet

Cable tray SKS-Magic® 110, unperforated FT

Item number: 6059865



Loads

Insertable support spacings, min.	1.5 m
Insertable support spacings, max.	4 m
Support spacing 1.5 m	3 kN/m
Support spacing 2.0 m	2.4 kN/m
Support spacing 2.5 m	1.76 kN/m
Support spacing 3.0 m	1.2 kN/m
Support spacing 3.5 m	0.84 kN/m
Support spacing 4.0 m	0.8 kN/m

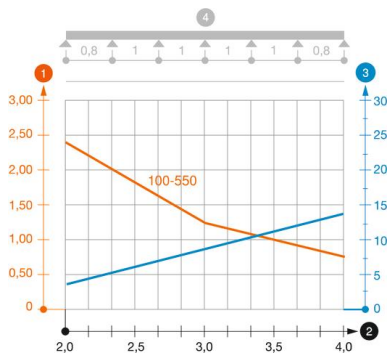

Load diagram, cable tray, type SKSMU 110

- 1 Permitted cable tray/ladder load in kN/m without man load
- 2 Support width in m
- 3 Rail bend in mm at permitted kN/m
- 4 Load scheme during testing
- Load curve with cable tray/ladder width in mm
- Strut bend curve according to support width