

Technical data sheet

Reducer / stop-end DD

Item number: 7107404



Reducer/stop-end for cable trays with side height 85 mm.
From a width of 150 mm, a perforated bottom flange is available.

Including appropriate fastening material.

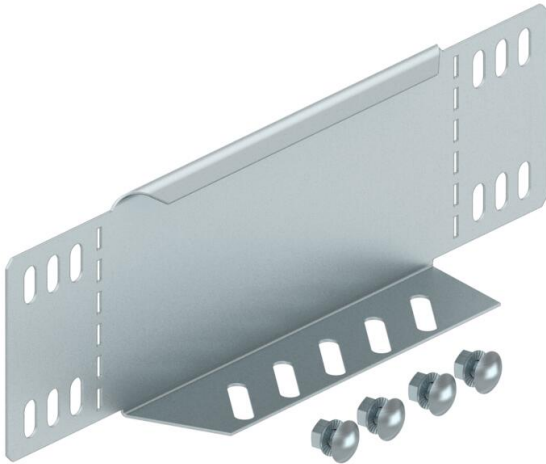

St Steel

DD Strip galvanised zinc/aluminium, Double Dip

Master data

Item number	7107404
Type	RWEB 850 DD
Description 1	Reducer profile/end closure
Description 2	for cable tray
Manufacturer	OBO
Dimension	85x500
Material	Steel
Surface	Strip galvanised zinc/aluminium, Double Dip
Surface standard	DIN EN 10346
Smallest sales unit	1
Unit of quantity	Piece
Weight	53 kg
Weight unit	kg/100 pc.

Technical data sheet

Reducer / stop-end DD

Item number: 7107404



Dimensions

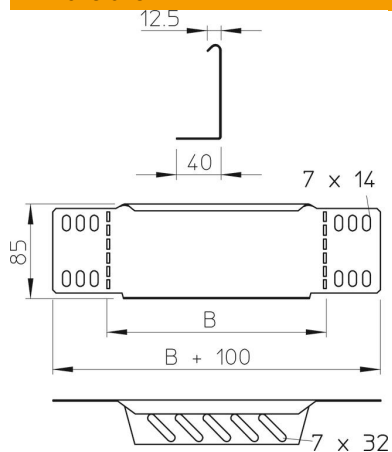

Width	500 mm
Width	20 in
Height	85 mm
Height	3 in
Plate thickness	1 mm
Dimension B	500 mm

Technical data

Maintain electrical functions	no
Rustproof steel, pickled	no