

Technical data sheet

Reducer / stop-end FS

Item number: 7108052



Reducer/stop-end for cable trays with side height 35 mm.
From a width of 150 mm, a perforated bottom flange is available.

Including appropriate fastening material.

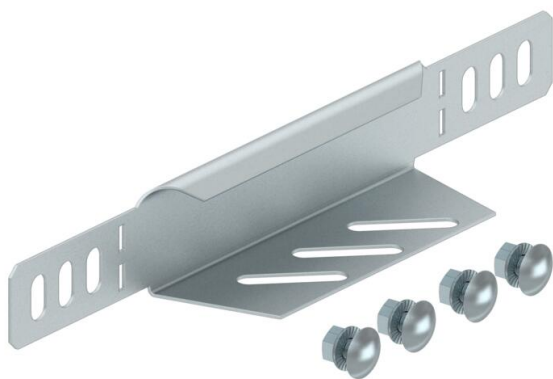

St Steel

FS Strip galvanized

Master data

Item number	7108052
Description 1	Reducer profile/end closure
Description 2	for cable tray
Manufacturer	OBO
Dimension	35x50
Colour	zinc
Material	Steel
Surface	Strip galvanized
Surface standard	DIN EN 10346
Smallest sales unit	1
Unit of quantity	Piece
Weight	4.2 kg
Weight unit	kg/100 pc.

Technical data sheet

Reducer / stop-end FS

Item number: 7108052



Dimensions

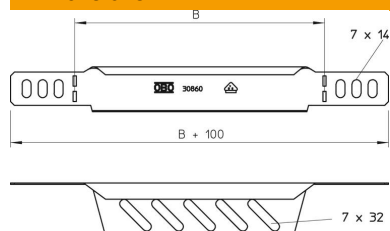

Width	50 mm
Width	2 in
Height	35 mm
Height	1 in
Plate thickness	1 mm
Dimension B	50 mm

Technical data

Maintain electrical functions	no
Rustproof steel, pickled	no
Wide-span version	no