

Technical data sheet

90° Magic bend 85 FS

Item number: 6041492



90° bend with quick connector system. For all cable tray types of 85 mm side height.

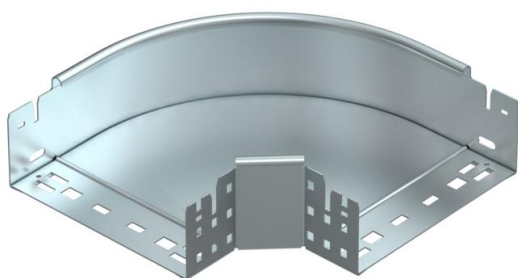

St Steel

FS Strip galvanized

Master data

Item number	6041492
Description 1	90° bend
Description 2	with quick connector
Manufacturer	OBO
Dimension	85x200
Material	Steel
Surface	Strip galvanized
Surface standard	DIN EN 10346
Smallest sales unit	1
Unit of quantity	Piece
Weight	138.2 kg
Weight unit	kg/100 pc.

Technical data sheet

90° Magic bend 85 FS

Item number: 6041492



Dimensions

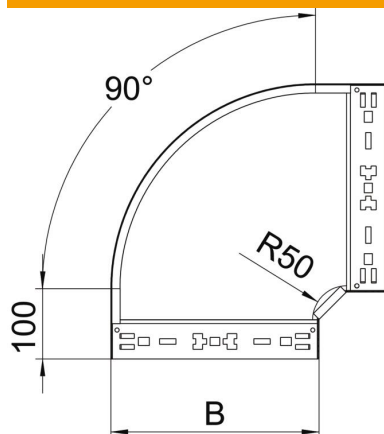

Width	200 mm
Height	85 mm
Plate thickness	1.25 mm
Dimension B	200 mm

Technical data

Bend (angle)	90°
Connector version	Integrated connector
Maintain electrical functions	no
Mounting perforation in base	no
NATO hole pattern	no
Change of direction	Horizontal
Rustproof steel, pickled	no
Side perforation	no
Wide-span version	no
Type of connector, cable support system	Click fastening