

# Technical data sheet

## Hammer-head bolt ZL

Item number: 1148318



Hammer-head bolt for use with MS4121 and MS4141 profile rails

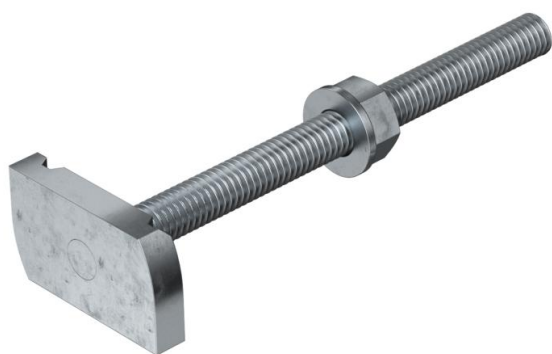

**St** Steel

**ZL** Zinc slat

### Master data

Item number	1148318
Type	MS41HB M8x100 ZL
Description 1	Hammerhead screw
Description 2	for profile rail MS4121/4141
Manufacturer	OBO
Dimension	M8x100mm
Material	Steel
Surface	Zinc slat
Surface standard	
Smallest sales unit	20
Unit of quantity	Piece
Weight	7.6 kg
Weight unit	kg/100 pc.

# Technical data sheet

## Hammer-head bolt ZL

Item number: 1148318



### Dimensions

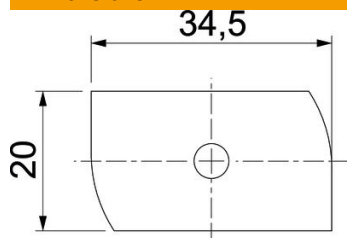

Length	34.5 mm
Width	20 mm
Height	6 mm
Dimension H	6 mm
Dimension L	100 mm

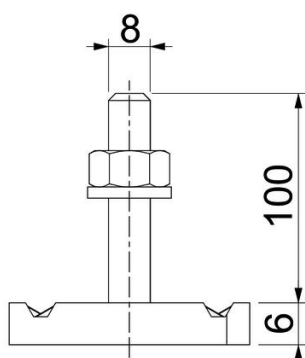

### Technical data

Torque	8 Nm
Suitable for mounting rail	yes
Thread	M 8 x 100
Washer Ø	16 mm