

Technical data sheet

Hammer-head bolt ZL

Item number: 1148338



Hammer-head bolt for use with MS4121 and MS4141 profile rails

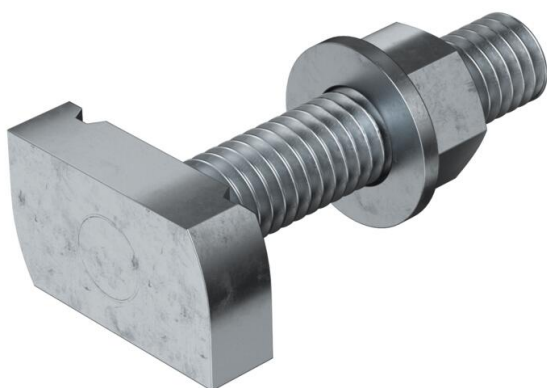

St Steel

ZL Zinc slat

Master data

Item number	1148338
Type	MS41HB M12x60 ZL
Description 1	Hammerhead screw
Description 2	for profile rail MS4121/4141
Manufacturer	OBO
Dimension	M12x60mm
Material	Steel
Surface	Zinc slat
Surface standard	
Smallest sales unit	25
Unit of quantity	Piece
Weight	12.4 kg
Weight unit	kg/100 pc.

Technical data sheet

Hammer-head bolt ZL

Item number: 1148338



Dimensions

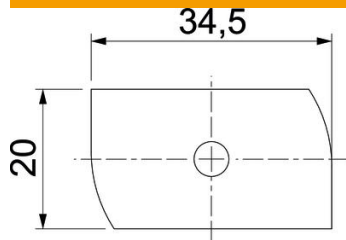

Length	34.5 mm
Width	20 mm
Height	9 mm
Dimension H	9 mm
Dimension L	60 mm

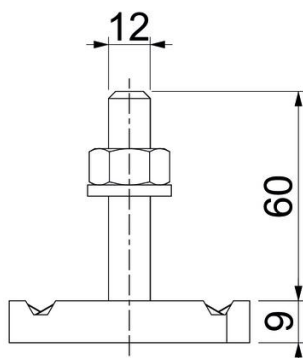

Technical data

Torque	27 Nm
Suitable for mounting rail	yes
Thread	M 12 x 60
Washer Ø	24 mm