

Technical data sheet

MS4121 mounting rail, slot 22 mm, FS, perforated

Item number: 1122953



Heavy-duty C profile rail for individual installation of support constructions, e.g. for cable trays or as a panel for switchgear cabinets. Can also be used for cable routing, in conjunction with clamp clips with a U foot.



St Steel

FS Strip galvanized

Master data

Item number	1122953
Type	MS4121P0400FS
Description 1	Profile rail
Description 2	perforated, slot 22mm
Manufacturer	OBO
Dimension	400x41x21
Material	Steel
Surface	Strip galvanized
Surface standard	DIN EN 10346
Smallest sales unit	1
Unit of quantity	Piece
Weight	56.4 kg
Weight unit	kg/100 pc.

Technical data sheet

MS4121 mounting rail, slot 22 mm, FS, perforated

Item number: 1122953



Dimensions

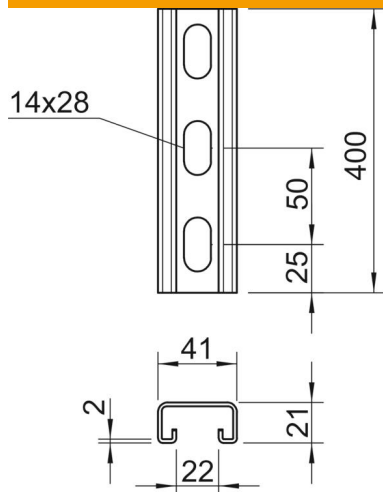

Length	400 mm
Width	41 mm
Height	21 mm
Dimension L	400 mm

Technical data

Breakable	no
Type of perforation	Perforated back
Version for	Single profile
Drill hole spacing, centre	50 mm
Maintain electrical functions	no
Material thickness	2 mm
With perforation	no
With tothing	yes
Profile shape	C profile
Slot width	22 mm
Static value A	1.65 cm ²
Static value I _y	0.95 cm
Static value I _z	4.51 cm
Static value W _y	0.89 cm ²
Static value W _z	2.2 cm ²