

Technical data sheet

Centre suspension, universal FT

Item number: 6358892



Universal centre suspension for fastening to threaded rods and supports.
Preferred use of this centre suspension in combination with cable ladders and mesh cable trays.



St Steel

FT Hot-dip galvanised

Master data

Item number	6358892
Type	MAHU 400 FT
Description 1	Centre suspension
Description 2	universal
Manufacturer	OBO
Dimension	B400mm
Material	Steel
Surface	Hot-dip galvanised
Surface standard	DIN EN ISO 1461
Smallest sales unit	1
Unit of quantity	Piece
Weight	71.3 kg
Weight unit	kg/100 pc.

Technical data sheet

Centre suspension, universal FT

Item number: 6358892



Dimensions

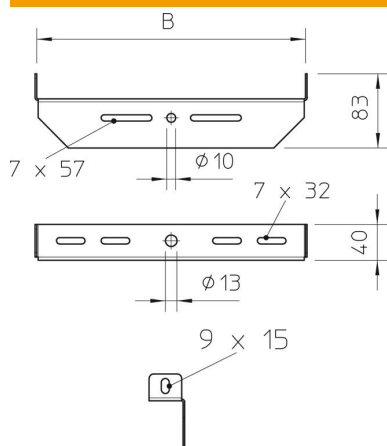

Width	400 mm
-------	--------

Technical data

Suitable for metric threaded rod	12
Adjustable	no