

Technical data sheet

Adjustable connector A2

Item number: 6208947

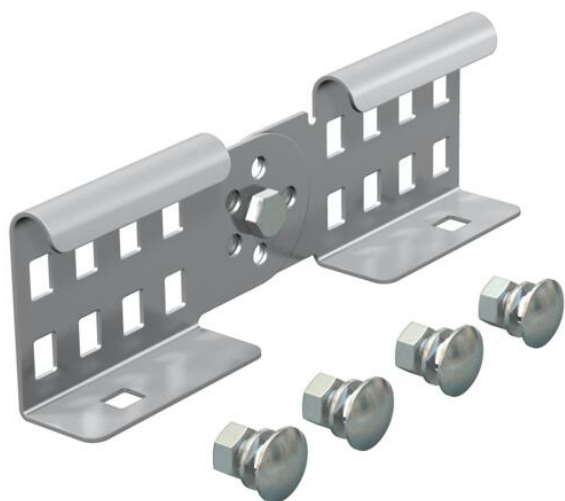

Adjustable connector as external connector to join cable ladders and fittings with a side height of 60 mm and continuous rail perforation. Angle can be adjusted vertically.

The bolt fastening ensures the continuity of the equipotential bonding.



A2 Stainless steel

2B Bright, treated

Master data

Item number	6208947
Type	LGVG 60 A2
Description 1	Adjustable connector
Description 2	for cable ladder
Manufacturer	OBO
Dimension	64x210
Material	Stainless steel
Surface	Bright, treated
Surface standard	
Smallest sales unit	10
Unit of quantity	Piece
Weight	28.5 kg
Weight unit	kg/100 pc.

Technical data sheet

Adjustable connector A2

Item number: 6208947



Dimensions

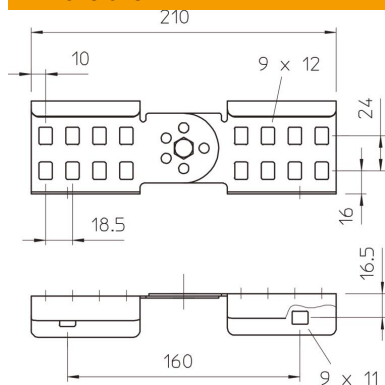

Dimension	64x210
Length	210 mm
Width	28 mm
Height	64 mm
Plate thickness	1.5 mm

Technical data

Version for	Straight and angle connector
Suitable for mesh cable tray	no
Suitable for cable ladder	yes
Suitable for cable tray	no
Suitable for cable tray system height	60 mm
Adjustable connector, horizontal	no
Articulated connector, vertical	yes
Rustproof steel, pickled	no
Connection type	Screw connector