

# Technical data sheet

## Adjustable bend element 60 A4

Item number: 6225486



Adjustable bend element with welded rung for use in cable ladder types with a side height of 60 mm.



**A4** Stainless steel

**2B** Bright, treated

### Master data

Item number	6225486
Type	LGBE 650 A4
Description 1	Adjustable bend element
Description 2	for cable ladder
Manufacturer	OBO
Dimension	60x500
Material	Stainless steel
Surface	Bright, treated
Surface standard	
Smallest sales unit	1
Unit of quantity	Piece
Weight	122.9 kg
Weight unit	kg/100 pc.

# Technical data sheet

## Adjustable bend element 60 A4

Item number: 6225486



### Dimensions

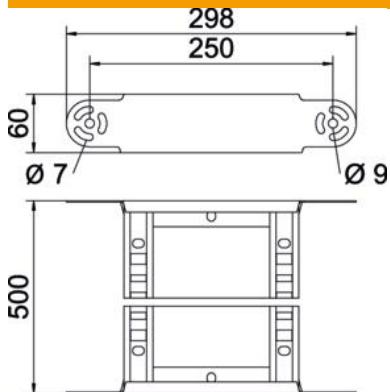

Width	500 mm
Height	60 mm
Dimension B	500 mm
Dimension R	500 mm

### Technical data

Bend (angle)	Adjustable
Version of the rungs	Profile perforated
Side rail version	Flat profile
Connector version	Integrated connector
Maintain electrical functions	no
Change of direction	Vertical, rising/falling
Rustproof steel, pickled	no
Hinged	no
Side perforation	no
Wide-span version	no
Rail thickness	1.5 mm