

Technical data sheet

Adjustable bend element 60 FT

Item number: 6225474



Adjustable bend element with welded rung for use in the cable ladder types with a side height of 60 mm.



St Steel

FT Hot-dip galvanised

Master data

Item number	6225474
Type	LGBE 640 FT
Description 1	Adjustable bend element
Description 2	for cable ladder
Manufacturer	OBO
Dimension	60x400
Material	Steel
Surface	Hot-dip galvanised
Surface standard	DIN EN ISO 1461
Smallest sales unit	1
Unit of quantity	Piece
Weight	116.4 kg
Weight unit	kg/100 pc.

Technical data sheet

Adjustable bend element 60 FT

Item number: 6225474



Dimensions

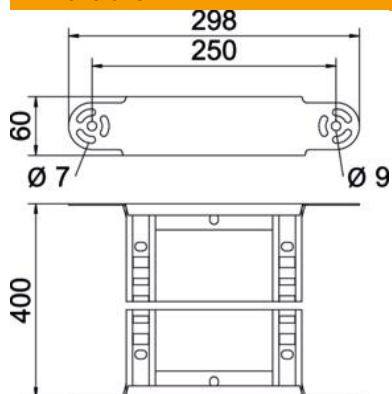

Width	400 mm
Height	60 mm
Dimension B	400 mm
Dimension R	400 mm

Technical data

Bend (angle)	Adjustable
Version of the rungs	Profile perforated
Side rail version	Flat profile
Connector version	Integrated connector
Maintain electrical functions	no
Change of direction	Vertical, rising/falling
Rustproof steel, pickled	no
Hinged	no
Side perforation	no
Wide-span version	no
Rail thickness	1.5 mm