

Technical data sheet

Clamping angle KWS FT

Item number: 6355250



Clamping angle, with hexagonal bolt, type KWS, for direct fixing of constructions to steel girder flanges.
Choose the clamping angle according to the thickness of the flange.



CE

St Steel

FT Hot-dip galvanised

Master data

Item number	6355250
Type	KWS 25 FT
Description 1	Clamping profile
Description 2	with hexagon screw, h = 25 mm
Manufacturer	OBO
Dimension	60x50
Material	Steel
Surface	Hot-dip galvanised
Surface standard	DIN EN ISO 1461
Smallest sales unit	10
Unit of quantity	Pair
Weight	80 kg
Weight unit	kg/100 pairs

Technical data sheet

Clamping angle KWS FT

Item number: 6355250



Dimensions

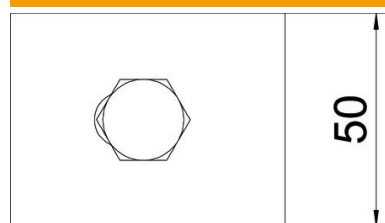

Height 25 mm

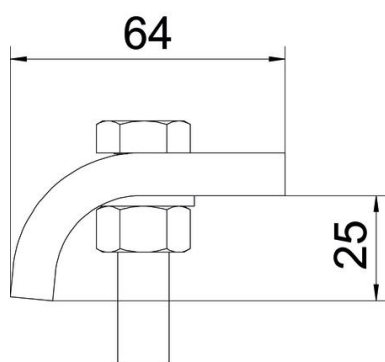

Technical data

F in kN	5.7 kN
Suitable for flange thickness, max.	28 mm
Suitable for flange thickness, min.	22 mm
Thread metric	12
Bolt	M12 x 60