

Technical data sheet

Plug-in seal for pipes, light grey

Item number: 2011546



Plug-in seal for junction boxes for direct insertion of metric pipes



TPE Thermoplastic elastomer

Master data

Item number	2011546
Type	EDR 40 32-40 LGR
Description 1	Plug-in seal
Description 2	for pipes
Manufacturer	OBO
Dimension	Ø40/32-40
Colour	Light grey; RAL 7035
Material	Thermoplastic elastomer
Smallest sales unit	25
Unit of quantity	Piece
Weight	2.2 kg
Weight unit	kg/100 pc.

Technical data sheet

Plug-in seal for pipes, light grey

Item number: 2011546



Dimensions

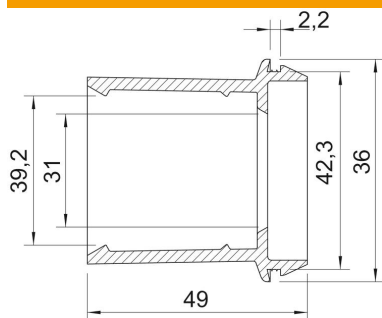

Dimension A	2.2 mm
Dimension D1	46 mm
Dimension D2	42.3 mm
Dimension D3	31 mm
Maß D4	39.2 mm
Dimension L	49 mm

Technical data

Version for	Open
for diameter, max.	40 mm
for diameter, min.	32 mm
for wall thickness, max.	2.2
for wall thickness, min.	2.2
Size	M40
Halogen-free	yes
Nominal diameter	40 mm
Protection rating	IP55