

Technical data sheet

Cover for 90° Magic bend FS

Item number: 7138512



Cover for 90° bend with premounted turn buckles.
The cover can be used with fittings of all side heights.



St Steel

FS Strip galvanized

Master data

| | |
|---------------------|---------------------|
| Item number | 7138512 |
| Description 1 | 90° bend cover |
| Description 2 | for bend RBM 90 600 |
| Manufacturer | OBO |
| Dimension | B=600mm |
| Material | Steel |
| Surface | Strip galvanized |
| Surface standard | DIN EN 10346 |
| Smallest sales unit | 1 |
| Unit of quantity | Piece |
| Weight | 338.1 kg |
| Weight unit | kg/100 pc. |

Technical data sheet

Cover for 90° Magic bend FS

Item number: 7138512



Dimensions

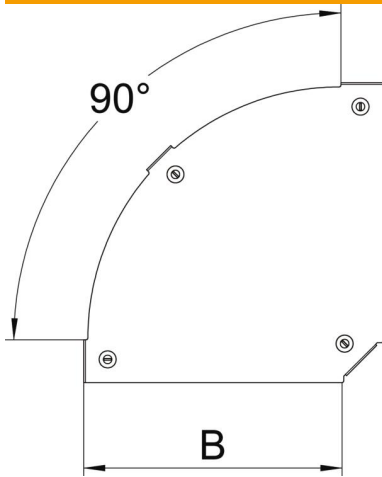

| | |
|-----------------|---------|
| Width | 600 mm |
| Width | 24 in |
| Plate thickness | 0.05 in |
| Plate thickness | 1.25 mm |
| Dimension B | 600 mm |

Technical data

| | |
|-------------------------------|------------|
| Bend (angle) | 90° |
| Fastening type | Sash lock |
| Maintain electrical functions | no |
| Suitable for mesh cable tray | no |
| Suitable for cable ladder | yes |
| Suitable for cable tray | yes |
| Change of direction | Horizontal |
| Rustproof steel, pickled | no |
| Hinged | no |