

Technical data sheet

Cover for 45° Magic bend FS

Item number: 7138368



Cover for 45° bend with pre-mounted turn buckles.
The cover can be used with fittings of all side heights.

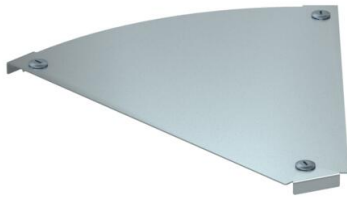

St Steel

FS Strip galvanized

Master data

Item number	7138368
Description 1	45° bend cover
Description 2	for bend RBM 45 400
Manufacturer	OBO
Dimension	B=400mm
Material	Steel
Surface	Strip galvanized
Surface standard	DIN EN 10346
Smallest sales unit	1
Unit of quantity	Piece
Weight	97.9 kg
Weight unit	kg/100 pc.

Technical data sheet

Cover for 45° Magic bend FS

Item number: 7138368

Dimensions

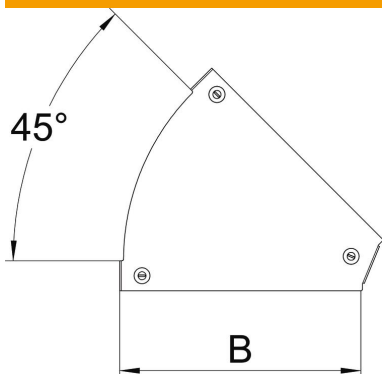

Width	400 mm
Width	16 in
Plate thickness	0.05 in
Plate thickness	1.25 mm
Dimension B	400 mm

Technical data

Bend (angle)	45°
Fastening type	Sash lock
Maintain electrical functions	no
Suitable for mesh cable tray	no
Suitable for cable ladder	no
Suitable for cable tray	yes
Change of direction	Horizontal
Rustproof steel, pickled	no
Hinged	no