

Technical data sheet

Beam clamp, for threaded rod

Item number: 1483665



Beam clamp for knocking in with threaded rod seat as individual fastening solution on the beam.



- St** Steel
- ZL** Zinc slat

Master data

Item number	1483665
Description 1	Beam clamp
Description 2	with threaded rod M8
Manufacturer	OBO
Dimension	4-8mm
Material	Steel
Surface	Zinc slat
Surface standard	
Smallest sales unit	50
Unit of quantity	Piece
Weight	3.1 kg
Weight unit	kg/100 pc.

Technical data sheet

Beam clamp, for threaded rod

Item number: 1483665



Dimensions

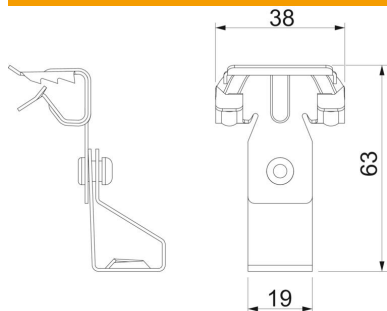

Dimension B	38 mm
Dimension L	63 mm

Technical data

Connection type/component	Thread
Fastening type	Clamp
Flange thickness F max.	8 mm
Flange thickness F min.	4 mm
Thread	M8
Thread metric	8
Hinge, adjustable	no
Hinged	no