

Technical data sheet

Spacer clip 732 A2

Item number: 1362644



Spacer clip for the installation of pipes and cables on walls, ceiling and floors. With self-locking upper part. Surfaces G and FT from a clip size of 20 are suitable for installation with a nail device or a bolt-firing tool.

Approved for the maintenance of electrical function according to DIN 4102 Part 12, maintenance of electrical function classes E30 to E90.



A2 Stainless steel

Master data

Item number	1362644
Type	ASG 732 44 A2
Description 1	Distance saddle
Description 2	with threaded connection M6
Manufacturer	OBO
Dimension	36-44mm
Material	Stainless steel
Smallest sales unit	20
Unit of quantity	Piece
Weight	4.099 kg
Weight unit	kg/100 pc.

Technical data sheet

Spacer clip 732 A2

Item number: 1362644



Dimensions

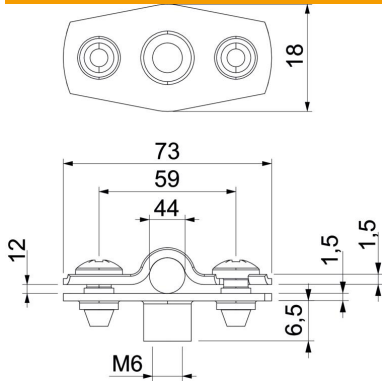

Dimension A	73 mm
Dimension B	59 mm
Dimension b	18 mm
Dimension D	44 mm
Dimension d max.	44 mm
Dimension d min.	36 mm
Dimension H1	12 mm
Dimension t1 (mm)	1.5
Dimension t2 (mm)	1.5
Dimension x	12 mm

Technical data

Distance to the wall	yes
Number of cables/pipes	1
Version for	Closed
For diameter	36 - 44
Suitable in fire protection area	yes
Halogen-free	yes
Plastic-covered	no
Material thickness	1.5 mm
Clamping range D, max.	44 mm
Clamping range D, min.	36 mm
UV-resistant	yes