

# Technical data sheet

## Spacer clip 732 FT

Item number: 1362367



Spacer clip for the installation of pipes and cables on walls, ceiling and floors. With self-locking upper part. Surfaces G and FT from a clip size of 20 are suitable for installation with a nail device or a bolt-firing tool.

Approved for the maintenance of electrical function according to DIN 4102 Part 12, maintenance of electrical function classes E30 to E90.



**St** Steel

**FT** Hot-dip galvanised

### Master data

Item number	1362367
Type	ASG 732 17 FT
Description 1	Distance saddle
Description 2	with threaded connection M6
Manufacturer	OBO
Dimension	14-17mm
Material	Steel
Surface	Hot-dip galvanised
Surface standard	DIN EN ISO 1461
Smallest sales unit	25
Unit of quantity	Piece
Weight	1.892 kg
Weight unit	kg/100 pc.

# Technical data sheet

## Spacer clip 732 FT

Item number: 1362367



### Dimensions

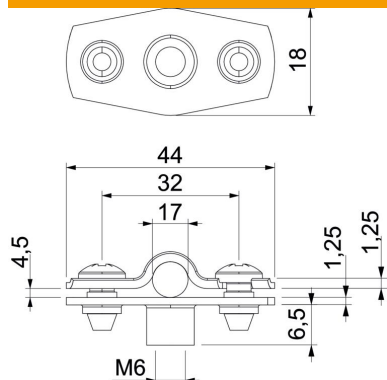

Dimension A	44 mm
Dimension B	32 mm
Dimension b	18 mm
Dimension D	17 mm
Dimension d max.	17 mm
Dimension d min.	14 mm
Dimension H1	6.5 mm
Dimension t1 (mm)	1.25
Dimension t2 (mm)	1.25
Dimension x	4.5 mm

### Technical data

Distance to the wall	yes
Number of cables/pipes	1
Version for	Closed
Fastening type	Threaded connection
For diameter	14 - 17
Suitable in fire protection area	yes
Halogen-free	yes
Plastic-covered	no
Material thickness	1.25 mm
Clamping range D, max.	17 mm
Clamping range D, min.	14 mm
UV-resistant	yes