

Technical data sheet

Earthing clamp, type 925

Item number: 5040035

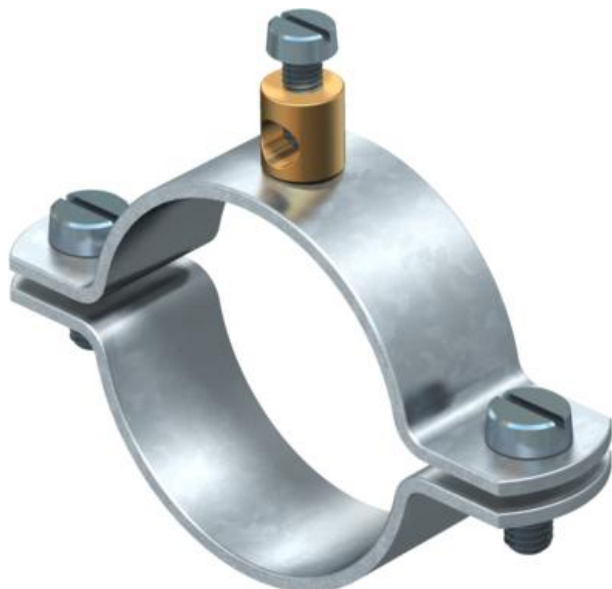

- For pipes 1/4"-1 1/2" or Ø 11.5-48.3 mm
- Connection options: conductors to 16 mm² with connecting terminal, riveted with brass
and 1 cylinder bolt M5 x 12
- To 1 1/2" with 2 cylinder bolts M6 x 16 (G)

St Steel

G Electrogalvanized

Master data

Item number	5040035
Type	925 1/4
Description 1	Earthing clamp
Description 2	for cables to 16 mm ²
Manufacturer	OBO
Dimension	1/4"
Material	Steel
Surface	Electrogalvanized
Surface standard	EN ISO 19598 / EN ISO 4042
Smallest sales unit	25
Unit of quantity	Piece
Weight	4.1 kg
Weight unit	kg/100 pc.

Technical data sheet

Earthing clamp, type 925

Item number: 5040035



Dimensions

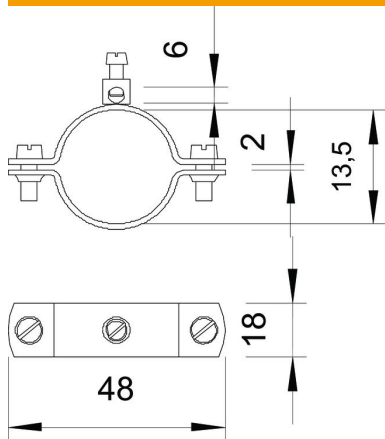

Dimension A	48 mm
Dimension b	18 mm
Dimension D	13.5 mm
Dimension X	2 mm

Technical data

Number of conductors	1
For pipe diameter, max.	13.5 mm
For pipe diameter, min.	11.5 mm
Cross-section of cable to be connected, max.	16 mm ²
Cross-section of cable to be connected, min.	0 mm ²
Clamping range D	1/4
Clamping range D, max.	13.5 mm
Clamping range D, min.	11.5 mm