

Technical data sheet

Fastening clip 604, light duty

Item number: 1003038



Single-lobe fastening clip for cables and pipes.
* Sizes 3 and 4 are not suitable for nail device
* Sizes 3 to 21 are not suitable for bolt-firing tool



St Steel

G Electrogalvanized

Master data

Item number	1003038
Type	604 3 G
Description 1	Fastening clip
Description 2	single lobe
Manufacturer	OBO
Dimension	3mm
Material	Steel
Surface	Electrogalvanized
Surface standard	EN ISO 19598 / EN ISO 4042
Smallest sales unit	100
Unit of quantity	Piece
Weight	0.052 kg
Weight unit	kg/100 pc.

Technical data sheet

Fastening clip 604, light duty

Item number: 1003038



Dimensions

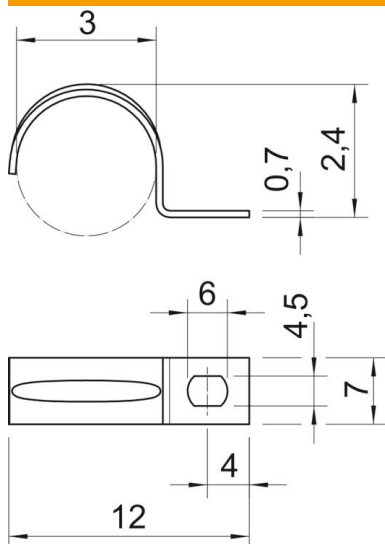

Length	12 mm
Width	7 mm
Height	2.4 mm
Dimension A	4 mm
Dimension b	7 mm
Dimension D	3 mm
Dimension d	4.5 mm
Dimension e	6 mm
Dimension H	2.4 mm
Dimension L	12 mm
Dimension t	0.7 mm

Technical data

Distance to the wall	no
Number of cables/pipes	1
Version for	Single-lobe
Fastening type	Screw hole
For diameter	3
Suitable in fire protection area	no
Halogen-free	yes
Plastic-covered	no
Hole size	4,5 x 6 mm
Material thickness	0.7 mm
Nominal diameter	3 mm
UV-resistant	yes