

Technical data sheet

Locknut, metric thread

Item number: 2091607



Locknut to DIN 46319 with metric thread IEC 423.

* Prices according to DEL notation.



CuZn
37 Brass

N Nickel-plated

Master data

Item number	2091607
Type	169 MS M12
Description 1	Locknut
Manufacturer	OBO
Dimension	M12
Material	Brass
Surface	Nickel-plated
Surface standard	
Smallest sales unit	100
Unit of quantity	Piece
Weight	0.22 kg
Weight unit	kg/100 pc.

Technical data sheet

Locknut, metric thread

Item number: 2091607



Dimensions

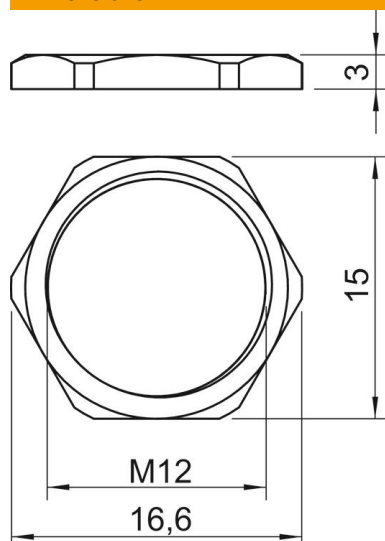

Dimension E	16.6 mm
Dimension L	3 mm

Technical data

Thread	M12_x_1,5
Thread type	Metric
Nominal thread size metric/PG	12
Fibre-glass reinforced	no
Halogen-free	no
Impact-resistant	no
WAF	15