

Technical data sheet

Reduction, metric thread

Item number: 2089556



Reduction (Part H) in accordance with DIN 46320, with metric thread to DIN EN 60423 or ISO 68.

* Prices according to DEL notation.



CuZn
37 Brass

N Nickel-plated

Master data

Item number	2089556
Type	167 R MS M25-20
Description 1	Reduction
Manufacturer	OBO
Dimension	M25-M20
Material	Brass
Surface	Nickel-plated
Surface standard	
Smallest sales unit	50
Unit of quantity	Piece
Weight	2.102 kg
Weight unit	kg/100 pc.

Technical data sheet

Reduction, metric thread

Item number: 2089556



Dimensions

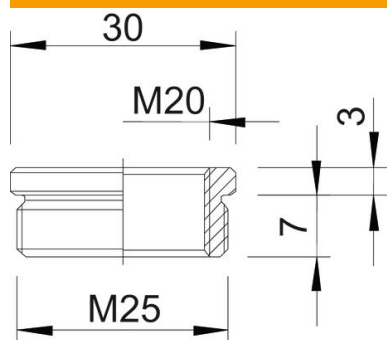

Dimension D	30 mm
Dimension L1	7 mm
Dimension L2	3 mm

Technical data

explosion-proof	no
Thread type: External thread	Metric
Thread type: Internal thread	Metric
Thread length	7 mm
Thread dimension, metric, external	25
Thread dimension, metric, internal	20
Nickel-plated	yes