

# Technical data sheet

Locknut, metric thread, black

Item number: 2049139



Locknut DIN 46319, with metric thread IEC 423.



PA Polyamide

## Master data

Item number	2049139
Description 1	Locknut
Manufacturer	OBO
Dimension	M63
Colour	Black
Material	Polyamide
Smallest sales unit	25
Unit of quantity	Piece
Weight	1.259 kg
Weight unit	kg/100 pc.

# Technical data sheet

Locknut, metric thread, black

Item number: 2049139



## Dimensions



Dimension E	83 mm
Dimension L	8 mm

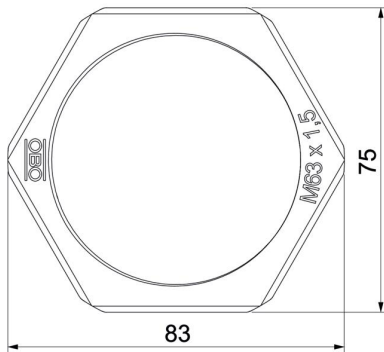

## Technical data

Thread	M63_x_1,5
Thread type	Metric
Nominal thread size metric/PG	63
Fibre-glass reinforced	no
Halogen-free	yes
Impact-resistant	no
WAF	75