

# Technical data sheet

## Reduction, metric thread

Item number: 2030628

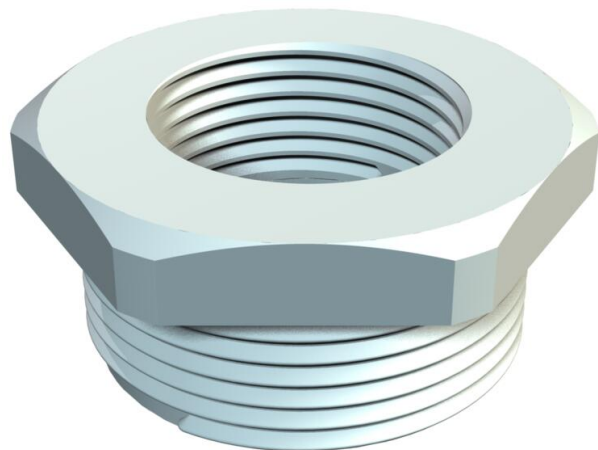

Reduction with metric internal and external thread for mounting plastic cable glands on enclosures. Protection class IP54 without additional connecting seal. Protection class up to IP68 possible with additional connecting seal, e.g. O-ring or flat sealing ring.



PA Polyamide

### Master data

Item number	2030628
Description 1	Reduction
Manufacturer	OBO
Dimension	M25-M20
Colour	Light grey; RAL 7035
Material	Polyamide
Smallest sales unit	100
Unit of quantity	Piece
Weight	0.65 kg
Weight unit	kg/100 pc.

# Technical data sheet

## Reduction, metric thread

Item number: 2030628



### Dimensions

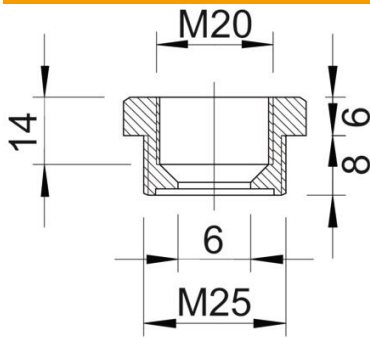

Dimension E	32 mm
Dimension L	14 mm
Dimension L1	8 mm
Dimension L2	6 mm
Dimension L3	14 mm

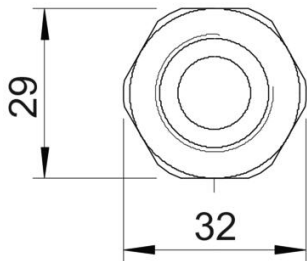

### Technical data

explosion-proof	no
Thread type: External thread	Metric
Thread type: Internal thread	Metric
Thread length	8 mm
Thread dimension, metric, external	25
Thread dimension, metric, internal	20
Halogen-free	yes
WAF	29
Nickel-plated	no