

Technical data sheet

Cone cable gland, PG thread, light grey

Item number: 2036487

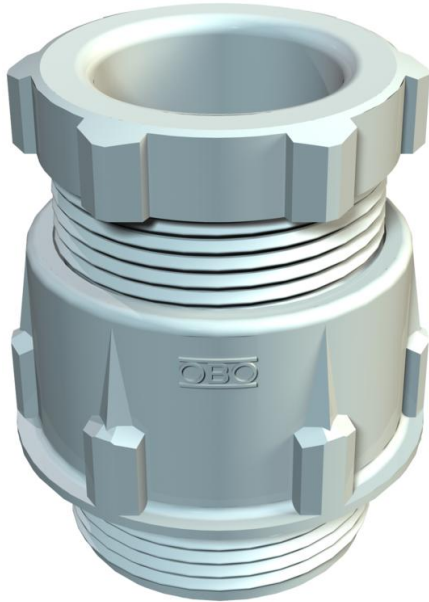

Standard cable gland, shape A, to DIN 46320 with simple NR/SBR sealing ring.
PG connection thread in accordance with DIN 40430.

Protection rating: with connection thread sealing ring IP65, without connection thread sealing ring IP54.

Note: Only tighten polystyrene cable glands lightly due to the risk of stress crack formation.

Shock-resistant



PS Polystyrene

Master data

Item number	2036487
Description 1	Cable gland
Manufacturer	OBO
Dimension	PG48
Colour	Light grey; RAL 7035
Material	Polystyrene
Smallest sales unit	5
Unit of quantity	Piece
Weight	7.336 kg
Weight unit	kg/100 pc.

Technical data sheet

Cone cable gland, PG thread, light grey

Item number: 2036487



Dimensions



Length	70 mm
Width	74 mm
Height	60 mm
Dimension D1	44 mm
Dimension D2	74 mm
Dimension D3	50 mm
Dimension D4	45.5 mm
Dimension G	Pg48 mm
Dimension L max.	48 mm
Dimension L1	14 mm
Dimension L2	27 mm
Dimension L3	9 mm
Dimension L4	18.5 mm

Technical data

Type of seal	Sealing ring
Version for	Straight
Bend protection	no
Sealing area D, max.	44 mm
Sealing area D, min.	37 mm
explosion-proof	no
For Ex zone	Without
For Ex zone gas	Without
For Ex zone dust	Without
Thread	Pg 48
Thread type	PG
Thread length	14 mm
Nominal thread size	48
Fibre-glass reinforced	no
Halogen-free	yes
Sealing insert, multiple	no
With locknut	no
Impact-resistant	no
WAF 1	65 mm
WAF 2	60 mm
Protection rating	IP65
Splittable gland	no
Strain relief option	no