

# Technical data sheet

## Cone cable gland, metric thread, light grey

Item number: 2035332

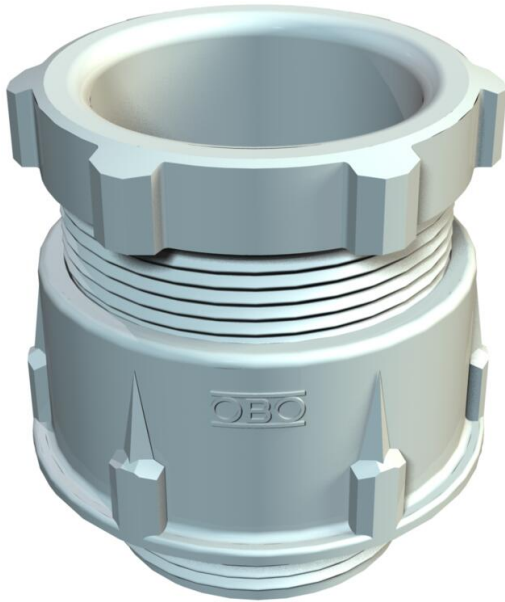

Standard cable gland, shape A, to DIN 46320 with simple NR/SBR sealing ring with metric connection thread to IEC 423.

Protection rating: with connection thread sealing ring IP65, without connection thread sealing ring IP54.

Note: Only tighten polystyrene cable glands lightly due to the risk of stress crack formation.  
Shock-resistant



PS Polystyrene

### Master data

Item number	2035332
Description 1	Cable gland
Manufacturer	OBO
Dimension	M20
Colour	Light grey; RAL 7035
Material	Polystyrene
Smallest sales unit	50
Unit of quantity	Piece
Weight	0.753 kg
Weight unit	kg/100 pc.
CO Footprint (GWP) Cradle-to-Gate	0,0294 kg COe / 1 Piece

# Technical data sheet

## Cone cable gland, metric thread, light grey

Item number: 2035332



### Dimensions

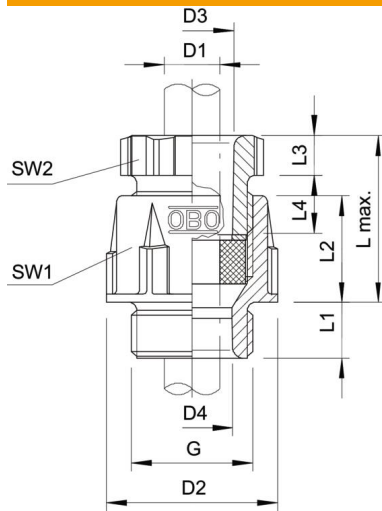

Length	27 mm
Width	27 mm
Height	35 mm
Dimension D1	13 mm
Dimension D2	27 mm
Dimension D3	13.4 mm
Dimension D4	13.5 mm
Dimension G	M20x1,5 mm
Dimension L max.	28 mm
Dimension L1	9 mm
Dimension L2	16 mm
Dimension L3	5 mm
Dimension L4	10.8 mm

### Technical data

Type of seal	Sealing ring
Version for	Straight
Bend protection	no
Sealing area D, max.	13 mm
Sealing area D, min.	9 mm
explosion-proof	no
For Ex zone	Without
For Ex zone gas	Without
For Ex zone dust	Without
Thread	M20 x 1,5
Thread type	Metric
Thread length	9 mm
Nominal thread size	20
Fibre-glass reinforced	no
Halogen-free	yes
Sealing insert, multiple	no
With locknut	no
Impact-resistant	yes
WAF 1	24 mm
WAF 2	21 mm
Protection rating	IP65
Splittable gland	no
Strain relief option	no