

Technical data sheet

Cover, T piece DD

Item number: 6038646



Cover for T piece fitting for lockable and screw-on cable trays in indoor and outdoor areas, to protect cables against damage and soiling. Fastening with pre-mounted sash lock and through attachment of the section cover. Suitable for all side heights.
The cover can be used with fittings of all side heights.



St Steel

DD Strip galvanised zinc/aluminium, Double Dip

Master data

Item number	6038646
Type	RTD 300 DD
Description 1	Cover
Description 2	for T piece
Manufacturer	OBO
Dimension	B300mm
Material	Steel
Surface	Strip galvanised zinc/aluminium, Double Dip
Surface standard	DIN EN 10346
Smallest sales unit	1
Unit of quantity	Piece
Weight	88 kg
Weight unit	kg/100 pc.

Technical data sheet

Cover, T piece DD

Item number: 6038646



Dimensions

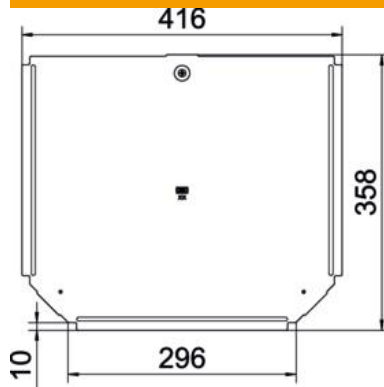

Width	300 mm
Plate thickness	0.75 mm
Dimension B	300 mm

Technical data

Number of turn buckles	1 St.
Fastening type	Sash lock
Suitable for cable ladder	no
Suitable for cable tray	yes
Material thickness	0.75 mm
Rustproof steel, pickled	no
Permitted temperature range, max.	120 °C
Permitted temperature range, min.	-20 °C
Wide-span version	no