

Technical data sheet

Height adjustment unit

Item number: 7399920



Height adjustment kit for IBK system components.

For levelling boxes, connectors and supports.



St Steel

FS Strip galvanized

Master data

Item number	7399920
Type	IBNEV 110
Description 1	Height-adjustment unit
Description 2	for IBK
Manufacturer	OBO
Material	Steel
Surface	Strip galvanized
Surface standard	DIN EN 10346
Smallest sales unit	10
Unit of quantity	Piece
Weight	15 kg
Weight unit	kg/100 pc.

Technical data sheet

Height adjustment unit

Item number: 7399920



Dimensions

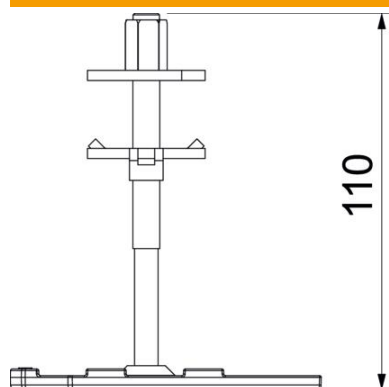

Length	92.5 mm
Width	36 mm
Height	110 mm
Dimension h	110 mm

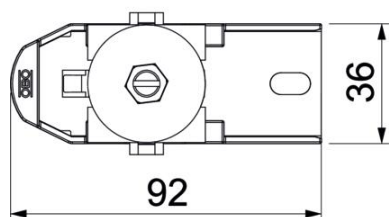

Technical data

Type of accessory	Miscellaneous
Height-adjustment range, max.	105 mm
Height-adjustment range, min.	35 mm