

# Technical data sheet

## Locknut, metric thread

Item number: 2091674



Locknut to DIN 46319 with metric thread IEC 423.

\* Prices according to DEL notation.



**CuZn** Brass  
37

**N** Nickel-plated

### Master data

Item number	2091674
Type	169 MS M50
Description 1	Locknut
Manufacturer	OBO
Dimension	M50
Material	Brass
Surface	Nickel-plated
Surface standard	
Smallest sales unit	50
Unit of quantity	Piece
Weight	3.07 kg
Weight unit	kg/100 pc.
CO Footprint (GWP) Cradle-to-Gate	0,1134 kg COe / 1 Piece

# Technical data sheet

## Locknut, metric thread

Item number: 2091674



### Dimensions

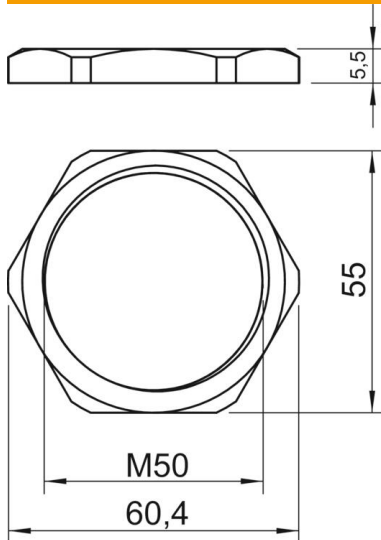

Dimension E	60.4 mm
Dimension L	5.5 mm

### Technical data

Thread	M50_x_1,5
Thread type	Metric
Nominal thread size metric/PG	50
Fibre-glass reinforced	no
Halogen-free	no
Impact-resistant	no
WAF	55