

Technical data sheet

Reduction, PG thread

Item number: 2030810

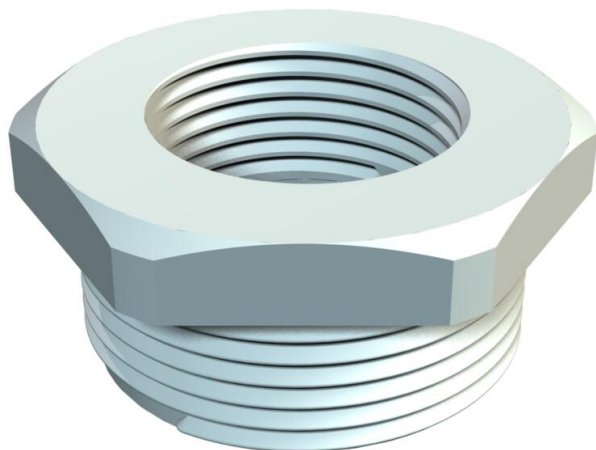

Reduction with PG internal and external thread to DIN 40430 for mounting plastic cable glands on enclosures. Protection class IP54 without additional connecting seal. Protection class up to IP68 possible with additional connecting seal, e.g. O-ring or flat sealing ring.



PA Polyamide

Master data

Item number	2030810
Description 1	Reduction
Manufacturer	OBO
Dimension	PG36-PG29
Colour	Light grey; RAL 7035
Material	Polyamide
Smallest sales unit	25
Unit of quantity	Piece
Weight	2.2 kg
Weight unit	kg/100 pc.
CO Footprint (GWP) Cradle-to-Gate	0,0948 kg COe / 1 Piece

Technical data sheet

Reduction, PG thread

Item number: 2030810



Dimensions

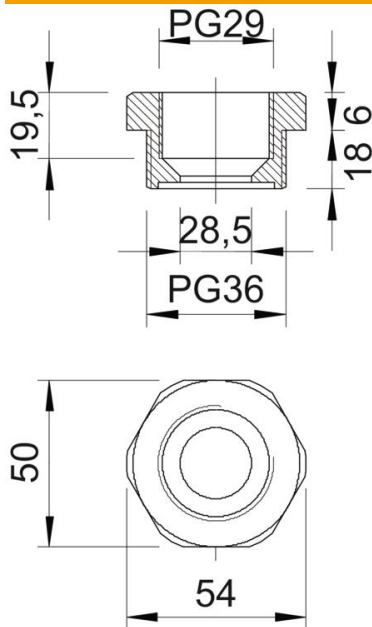

Dimension D	28.5 mm
Dimension E	54 mm
Dimension L1	18 mm
Dimension L2	6 mm
Dimension L3	19.5 mm

Technical data

explosion-proof	no
Thread type: External thread	PG
Thread type: Internal thread	PG
Thread length	18 mm
Thread dimension, PG, external	36
Thread dimension, PG, internal	29
Halogen-free	yes
WAF	50
Nickel-plated	no