

Technical data sheet

Reduction, metric thread

Item number: 2030667

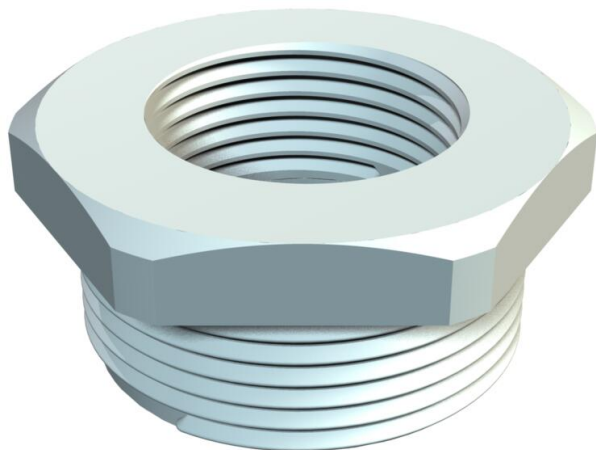

Reduction with metric internal and external thread for mounting plastic cable glands on enclosures. Protection class IP54 without additional connecting seal. Protection class up to IP68 possible with additional connecting seal, e.g. O-ring or flat sealing ring.



PA Polyamide

Master data

Item number	2030667
Description 1	Reduction
Manufacturer	OBO
Dimension	M63-M25
Colour	Light grey; RAL 7035
Material	Polyamide
Smallest sales unit	25
Unit of quantity	Piece
Weight	3.05 kg
Weight unit	kg/100 pc.
CO Footprint (GWP) Cradle-to-Gate	0,1088 kg COe / 1 Piece

Technical data sheet

Reduction, metric thread

Item number: 2030667



Dimensions

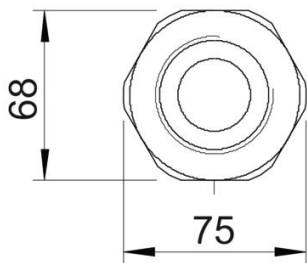
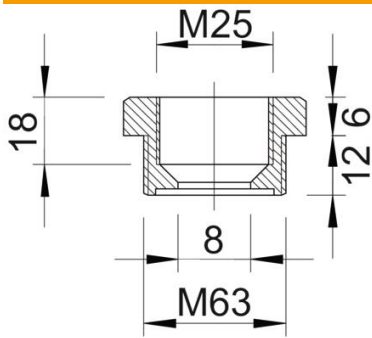

Dimension E	75 mm
Dimension L	18 mm
Dimension L1	12 mm
Dimension L2	6 mm
Dimension L3	18 mm

Technical data

explosion-proof	no
Thread type: External thread	Metric
Thread type: Internal thread	Metric
Thread length	12 mm
Thread dimension, metric, external	63
Thread dimension, metric, internal	25
Halogen-free	yes
WAF	68
Nickel-plated	no