

Technical data sheet

Reduction, metric thread

Item number: 2030624

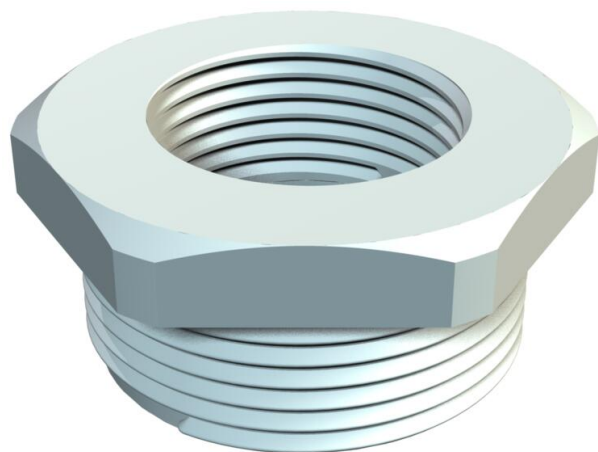

Reduction with metric internal and external thread for mounting plastic cable glands on enclosures. Protection class IP54 without additional connecting seal. Protection class up to IP68 possible with additional connecting seal, e.g. O-ring or flat sealing ring.



PA Polyamide

Master data

| | |
|-----------------------------------|-------------------------|
| Item number | 2030624 |
| Description 1 | Reduction |
| Manufacturer | OBO |
| Dimension | M25-M12 |
| Colour | Light grey; RAL 7035 |
| Material | Polyamide |
| Smallest sales unit | 100 |
| Unit of quantity | Piece |
| Weight | 0.85 kg |
| Weight unit | kg/100 pc. |
| CO Footprint (GWP) Cradle-to-Gate | 0,0324 kg COe / 1 Piece |

Technical data sheet

Reduction, metric thread

Item number: 2030624



Dimensions

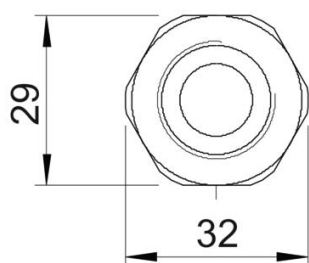
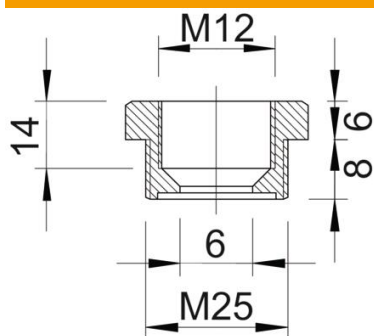

| | |
|--------------|-------|
| Dimension E | 32 mm |
| Dimension L | 14 mm |
| Dimension L1 | 8 mm |
| Dimension L2 | 6 mm |
| Dimension L3 | 14 mm |

Technical data

| | |
|------------------------------------|--------|
| explosion-proof | no |
| Thread type: External thread | Metric |
| Thread type: Internal thread | Metric |
| Thread length | 8 mm |
| Thread dimension, metric, external | 25 |
| Thread dimension, metric, internal | 12 |
| Halogen-free | yes |
| WAF | 29 |
| Nickel-plated | no |